

Product data sheet

Variable speed drive F510-4150-C3-IP00, 110KW, 150HP, 380-460V

Features

- Pump Cascade Control
- Hardware Safe Torque Off Function
- Conformity To Global Standards
- Communication protocols include BACnet, Metasys and Modbus
- Fire Override Mode
- Permanent-Magnet Motor Control Technology
- RTC Function/simple PLC
- Automatic Energy Saving Function

Component name		F510
Inverter Capacity(HP)		150
Output Rated	Rated Output Capacity(KVA)	158
	Rated Output Current(A)	208
	Maximum Applicable Motor (HP)	150
	(KW)	110
	Maximum Output Voltage(V)	Three Phase, 380-480V
Maximum Output Frequency(Hz)	Based on parameter setting 0.1~400.0Hz	
Input Power	Rated Voltage, Frequency	Three Phase, 380V-480V, 50/60Hz
	Allowable Voltage Fluctuation	-15% ~ +10%
	Allowable Frequency Fluctuation	±5%
Control characteristics	Display	LCD keypad(HOA LCD keypad option)
	Control Modes	V/F, SLV, PMSLV with Space Vector PWM Mode
	Output Frequency	0.1Hz~400.0Hz
	Frequency Accuracy	Digital references: ±0.01%(-10~ +40 °C), Analog references: ±0.1%(25 °C ± 10 °C),
	Speed Control Accuracy	±0.5%(sensorless Vector Control Mode)*1
	Frequency setting Resolution	Digital references: 0.01Hz, Analog references:0.06Hz/60Hz
	Output Frequency Resolution	0.01Hz
	Overload Tolerance	120%/1min
Frequency Setting Signal	DC 0~10V / 0~ 20mA or 4~ 20mA	

Product data sheet

Control characteristics	Acceleration/Deceleration Time	0.0~ 6000.0 second(separately set acceleration and deceleration time)
	Voltage/Frequency Characteristics	Can arbitrarily set V/F curve based on parameters
	Braking Torque	About 20%
	Main Control Functions	Auto tuning, Soft-PWM, Over-voltage protection, Dynamic braking, Speed search, Momentary power loss restart, 2 sets of PID control, Slide difference Compensation, RS-485 communication standard, Simple PLC function, 2 sets of analog outputs, Safety switch
	Other Functions	Records of power on and operation time, 4 fault history records and latest fault record state, Energy-saving function, Phase loss protection, Smart braking, DC braking, Dwell , S curve acceleration and deceleration, Up/Down operation, Modbus, BACnet MS/TP and Metasys N2 communication protocol, Display of multi-engineering unit, Local/ Remote switch, SINK/SOURCE input interface selection, User parameter settings
Protection Functions	Stall Protection	Current level can be set (in acceleration or constant speed; it can be set separately. In deceleration, it can be set with or without protection)
	Over Current(OC) and Output Short-circuit(SC) Protection	It stops when the output current exceeds 160% of the inverter rated current
	Inverter Overload Protection(OL2)	Inverter will be stopped when the output higher than 120% rated current for 1min, carrier frequency is 2~4KHZ *2
	Motor Overload Protection(OL1)	Electrical overload protection curve
	Over Voltage Protection(OV)	If the main circuit DC voltage rises over 820V (400V class), the motor stops running.
	Under Voltage Protection(UV)	If the main circuit DC voltage falls below 380V (400V class), the motor stops running
	Momentary power loss restart	Power loss exceeds 15ms. You can set the function of momentary power loss restart up to 2sec
	Overheat Protection(OH)	Thermistor sensor on heatsink
	Ground Fault Protection(GF)	Protection by current detection circuit
	Charge Indicator	When main circuit Dc voltage $\geq 50V$, the CHARGE LED is on
	Output Phase Loss Protection(OPL)	If the OPL function acts, the motor stops rotation automatically
Environment Specification	Location	Indoor (protected from corrosive gases and dust)
	Ambient Temperature	-10~+40°C (IP20/NEMA1 and IP55/NEMA12), -10~+50°C (IP00); with de-rating, its maximum operation temperature is 60°C
	Storage Temperature	-20~+70°C
	Humidity	95%RH or less (no condensation)
	Altitude and Vibration	Altitude of 1000 meters or lower,1.0G, in compliance with IEC 60068-2-6
Communication Function	Built-in RS-485 as standard (Modbus protocol with RJ45 / BACnet/ Metasys N2)	
PLC Function	Built-in	

Product data sheet

Electromagnetic Interference(EMI)	Meet EN61800-3 standard, IP20 400V 75HP or below and IP55 400V 60HP can be built in	
Electromagnetic Susceptibility(EMS)	Meet EN61800-3 standard	
Certification	CE	Meet EN61800-3 (CE & RE) and EN61800-5-1 (LVD)
	UL	UL508C
Option Card	1 to 8 Pump card, HOA LCD keypad, Profibus card	

Notes:

1. Speed control accuracy will be influenced when the motor and installation condition are different
2. The default setting of carrier frequency is different from models

External View

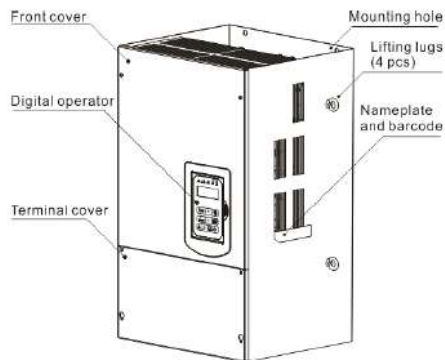

(Wall-mounted type, IEC IP00)

Inverter De-rating Based on Temperature

Rated Current Ratio	Temperature
100%	40°C
90%	45°C
80%	50°C
70%	55°C
60%	60°C

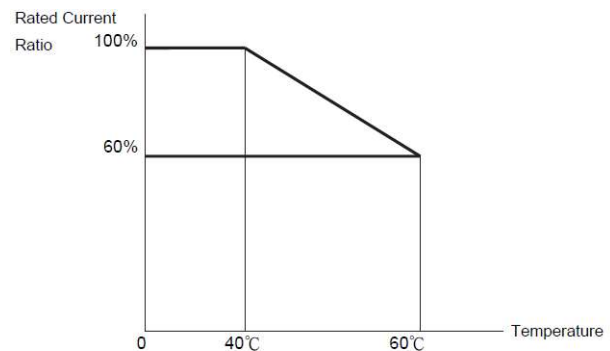

Note: User needs to adjust the inverter rated current depending on ambient temperature to ensure the appropriate industrial application

Product data sheet

General Wiring Diagram

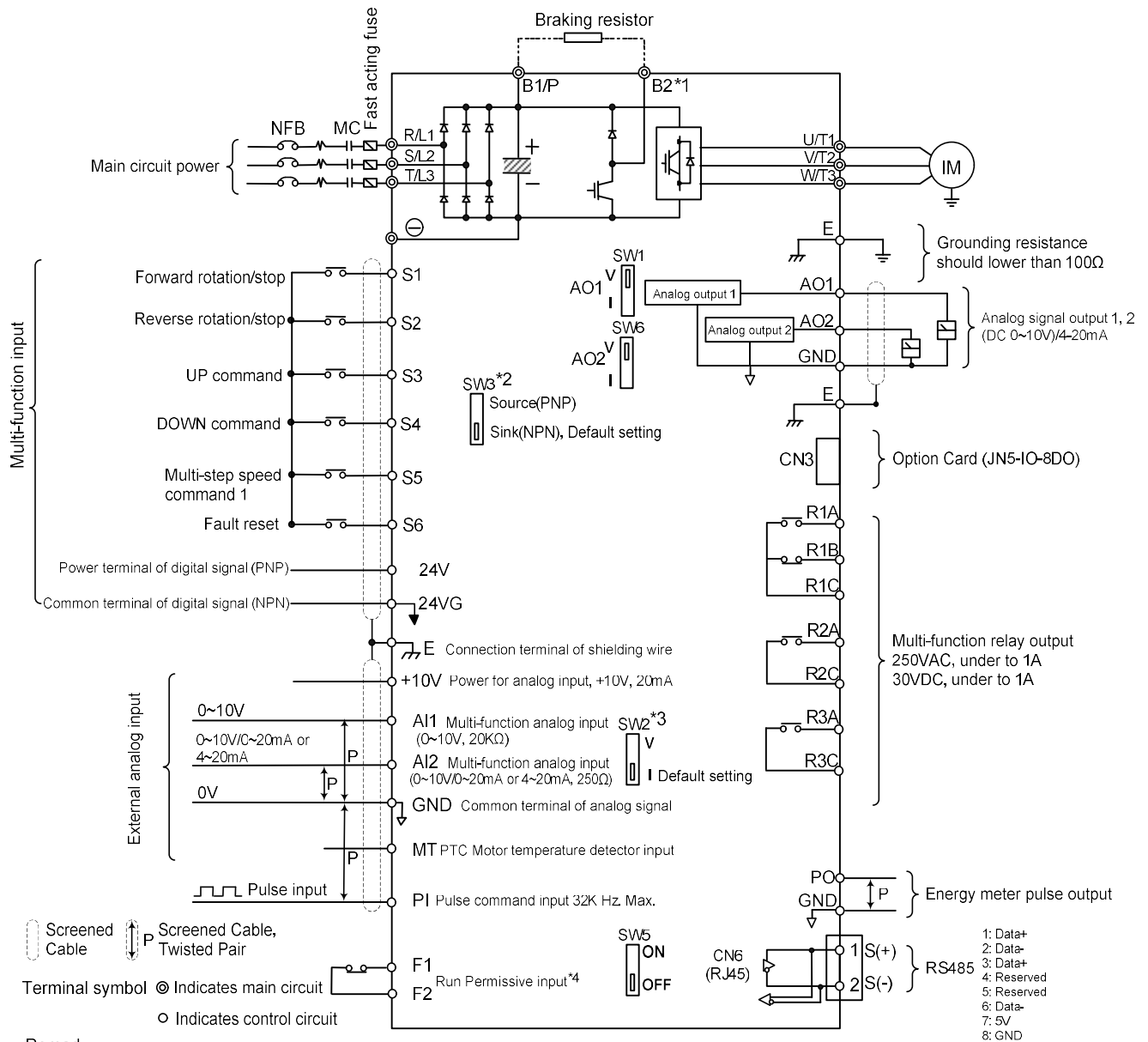

- 1: Data+
- 2: Data-
- 3: Data+
- 4: Reserved
- 5: Reserved
- 6: Data-
- 7: 5V
- 8: GND

Product data sheet

Dimensions

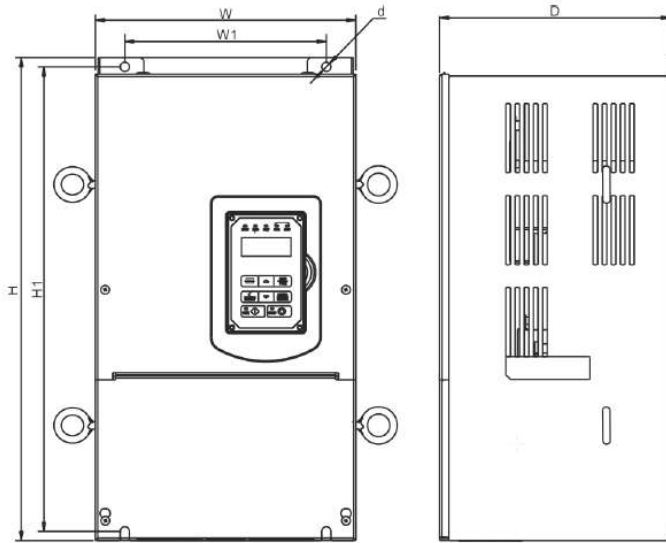

Inverter model	Dimensions in mm (inch)							NW in kg(lbs)
	W	H	D	W1	H1	t	d	
F510-4150-C3	459 (18.07)	790 (31.10)	324.5 (12.78)	320 (12.60)	760 (29.92)	1.6 (0.06)	M10	74 (163.14)

Installation Spaces

When installing the inverter, ensure that inverter is installed in upright position (vertical direction) and there is adequate space around the unit to allow normal heat dissipation as per the following figure.

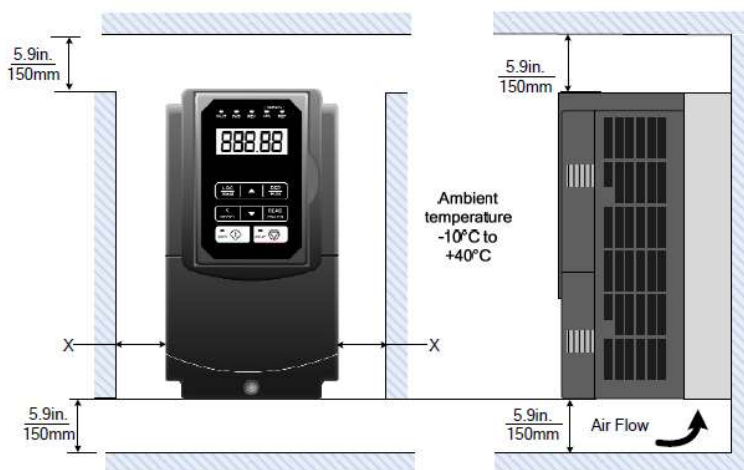

X = 1.18" (30mm) for inverter ratings up to 18.5kW
 X = 1.96" (50mm) for inverter ratings 22kW or higher

Important Note: The inverter heatsink temperature can reach up to 90°C/ 194°F during operation; make sure to use insulation material rated for this temperature.